



Subaru Telescope Operation Update

Michitoshi YOSHIDA

Director, Subaru Telescope

National Astronomical Observatory of Japan

Road blockage

- ◆ From July 16, the Maunakea access road has been blocked at the junction between MKAR and Daniel Inoué Highway by the protectors of Maunakea (protesters to TMT project).
- ◆ All the observations at Maunakea were cancelled from July 16 to August 9.
- ◆ Basic operations of the MK observatories were resumed from August 9.
- ◆ MK observatories still need to tell access information including the number of vehicles and arrival time at the junction to the law enforcement team or OMKM in advance (by 2 pm of the day before).

Earthquake

- ◇ 11/11/2019 6:35:52 AM
- ◇ ~11 km east-north-east of the Maunakea summit
- ◇ Magnitude 4.93 depth 32.6 km
- ◇ Shake level at the summit : “maybe 3 – 4 level on the Japanese seismic scale (震度3 – 4).” Takagi san said.

USGS seismometer at UKIRT

- Max. acceleration $\sim 0.6 \text{ m/s}^2$
- Max. displacement $\sim 2 \text{ mm ptp}$

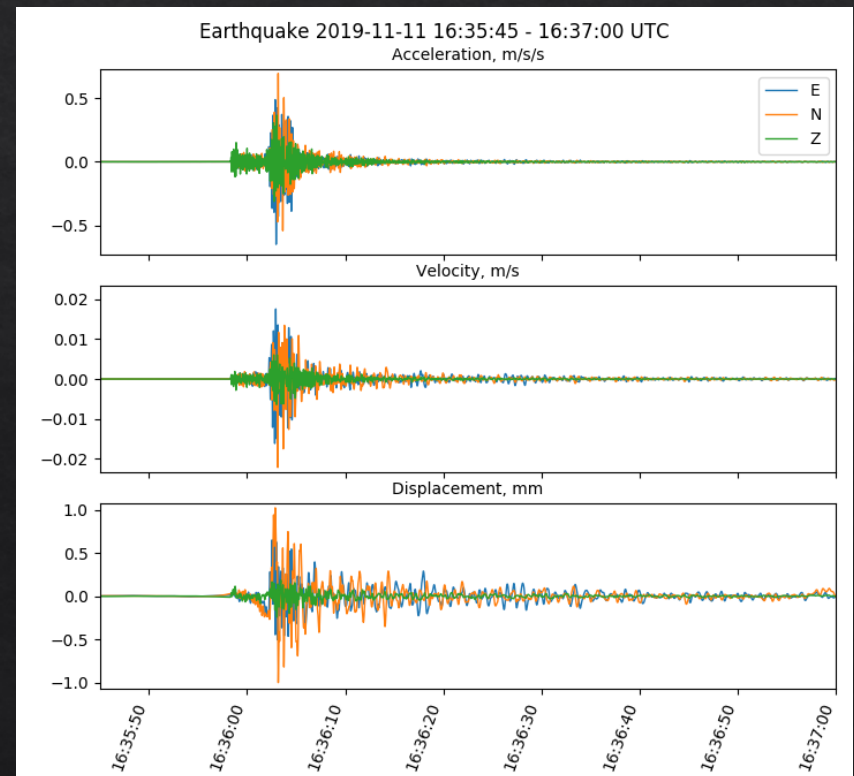

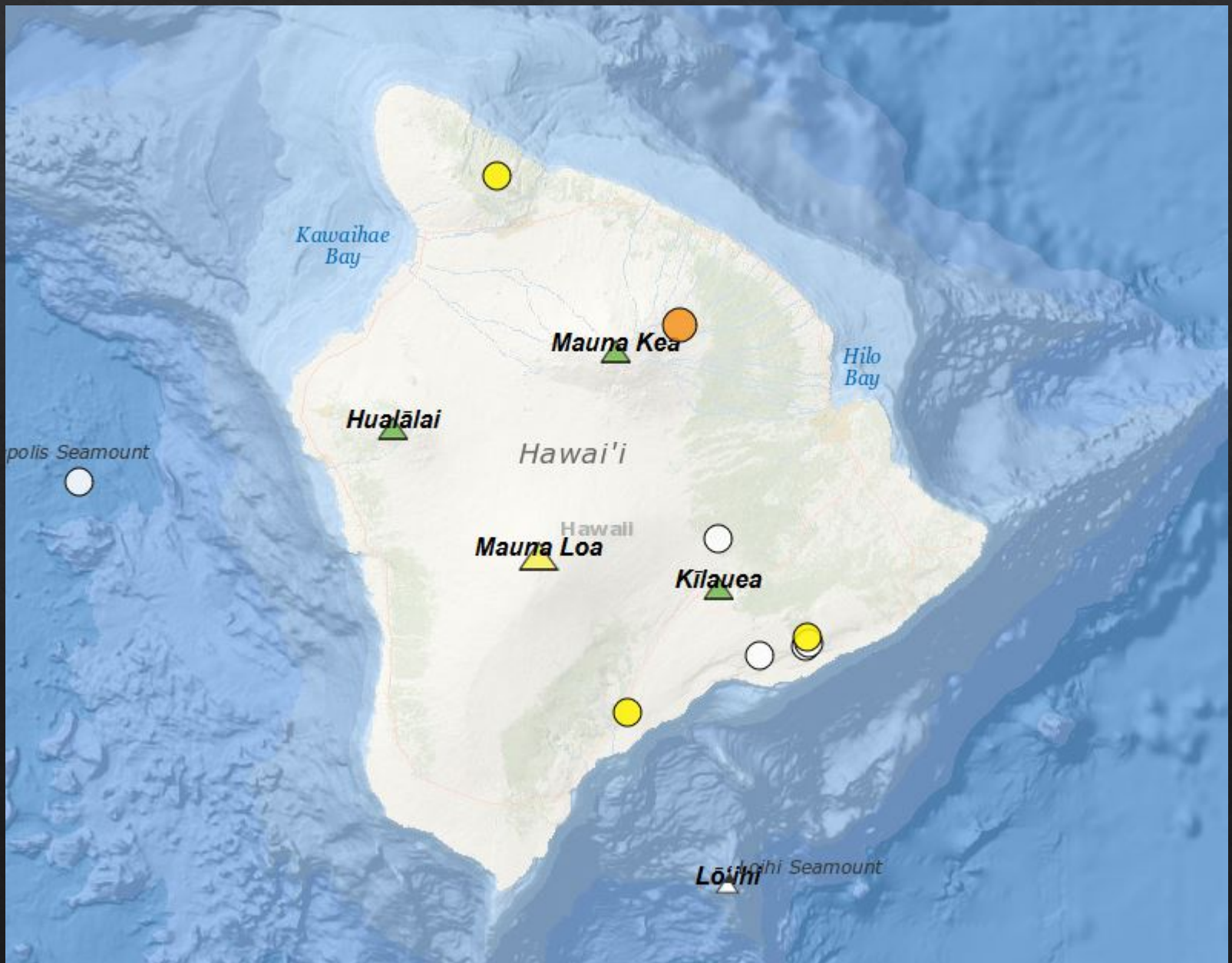

Influences to Subaru

- ◇ The primary mirror support system was completely stopped. → It will take two days to restore the system.
- ◇ A part of the ceiling of the summit lounge was damaged.
- ◇ Two elevators of the summit facility malfunctioned.
- ◇ Now all the TelDiv people are concentrating on the IR secondary mirror recoating and there is not enough manpower to perform both the recoating and the telescope repair at the same time. Re-assemble of the IR secondary mirror system was completed on 11/15.
- ◇ It will take three days more to recover the telescope and install HSC.
- ◇ Night observations from 11/11 to 11/19 were cancelled.

Installation of the mirror to the IRM2 unit is very much complicated.

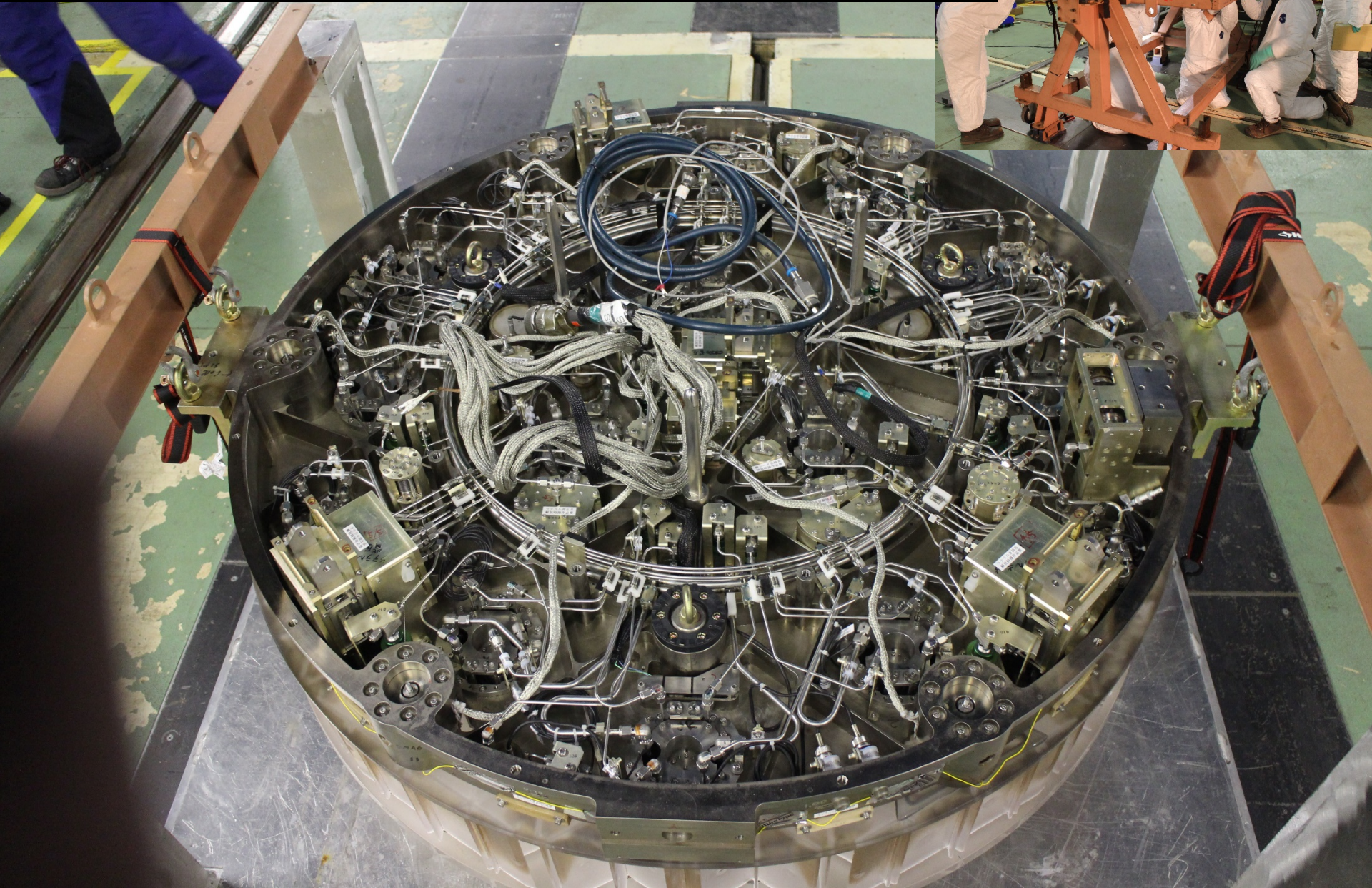



FY2019 Budget

FY2019 budget allocation by the government

- We got 6M USD (6.6億円) supplemental budget (補正予算) for 2019 and 2020.
- On the other hand, the government allocated 10M USD (10.2億円) for Subaru Operation.
- NAOJ will support 2M USD to fill the gap between the government allocation and real operation cost of Subaru.

FY2019 Budget

10K JPY
~ 100 USD

Subaru Budget 2018 & 2019

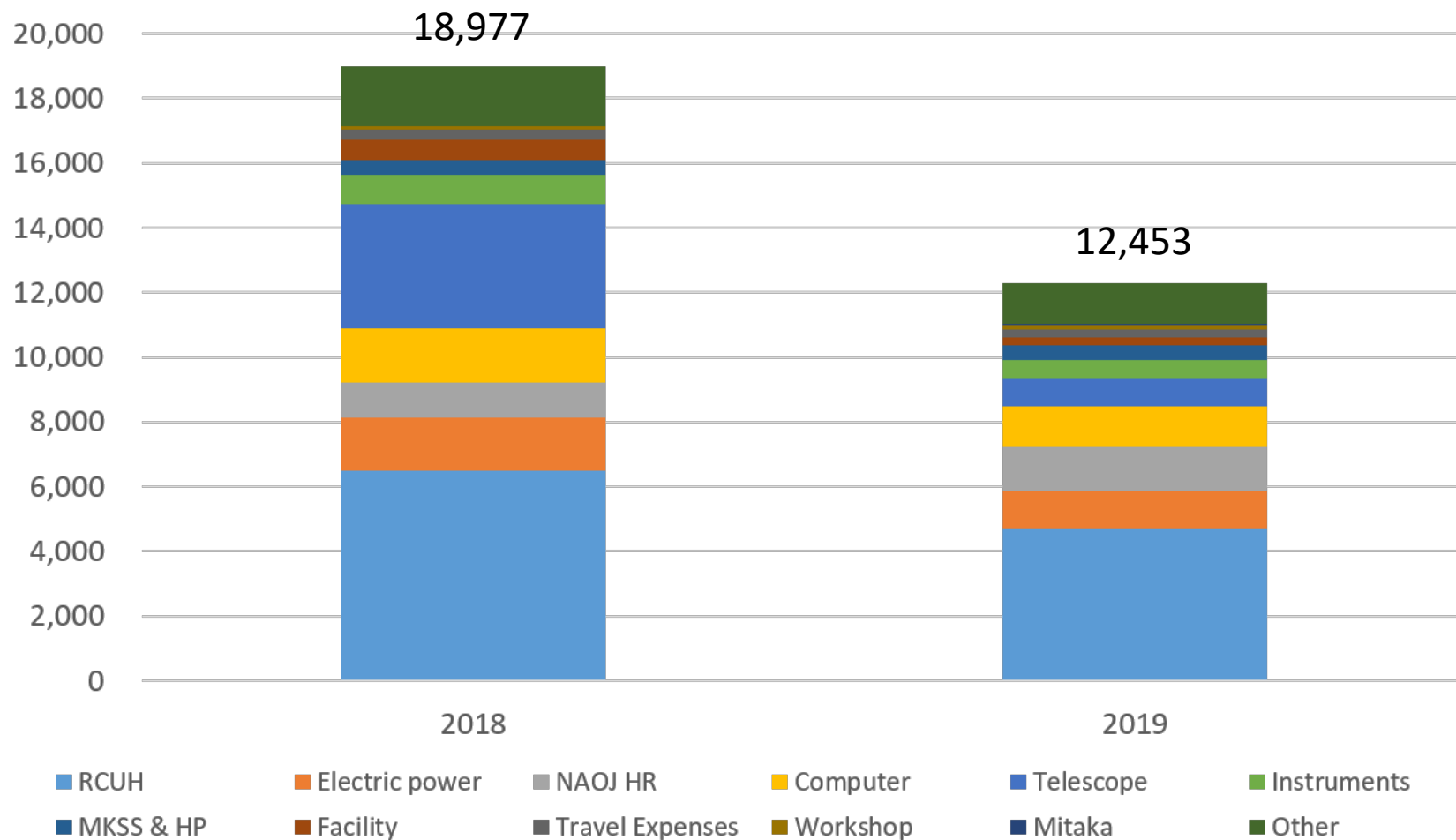

Subaru's budget structure in 2019

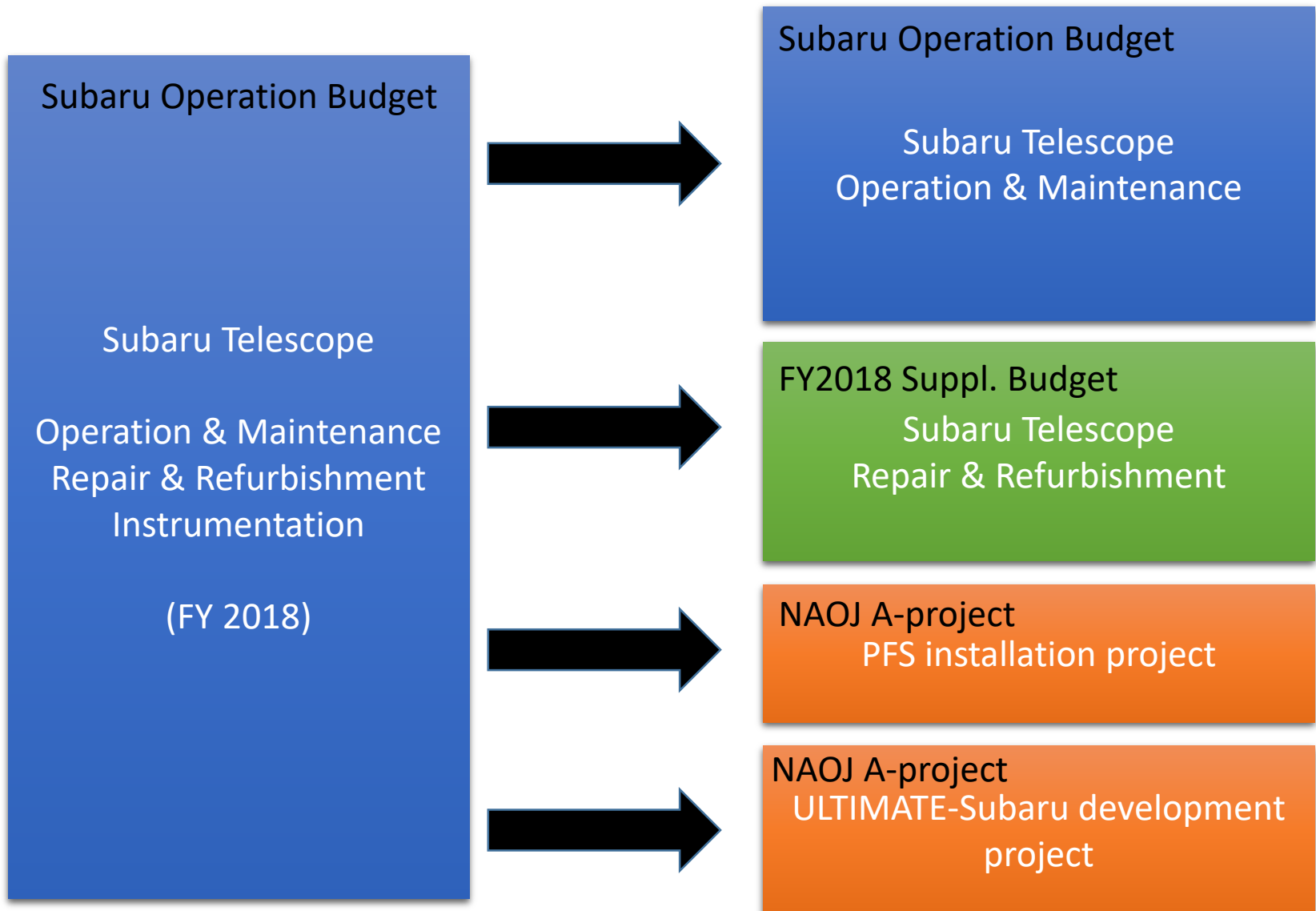

FY2019 Budget

10K JPY
~ 100 USD

Subaru Budget 2018 & 2019

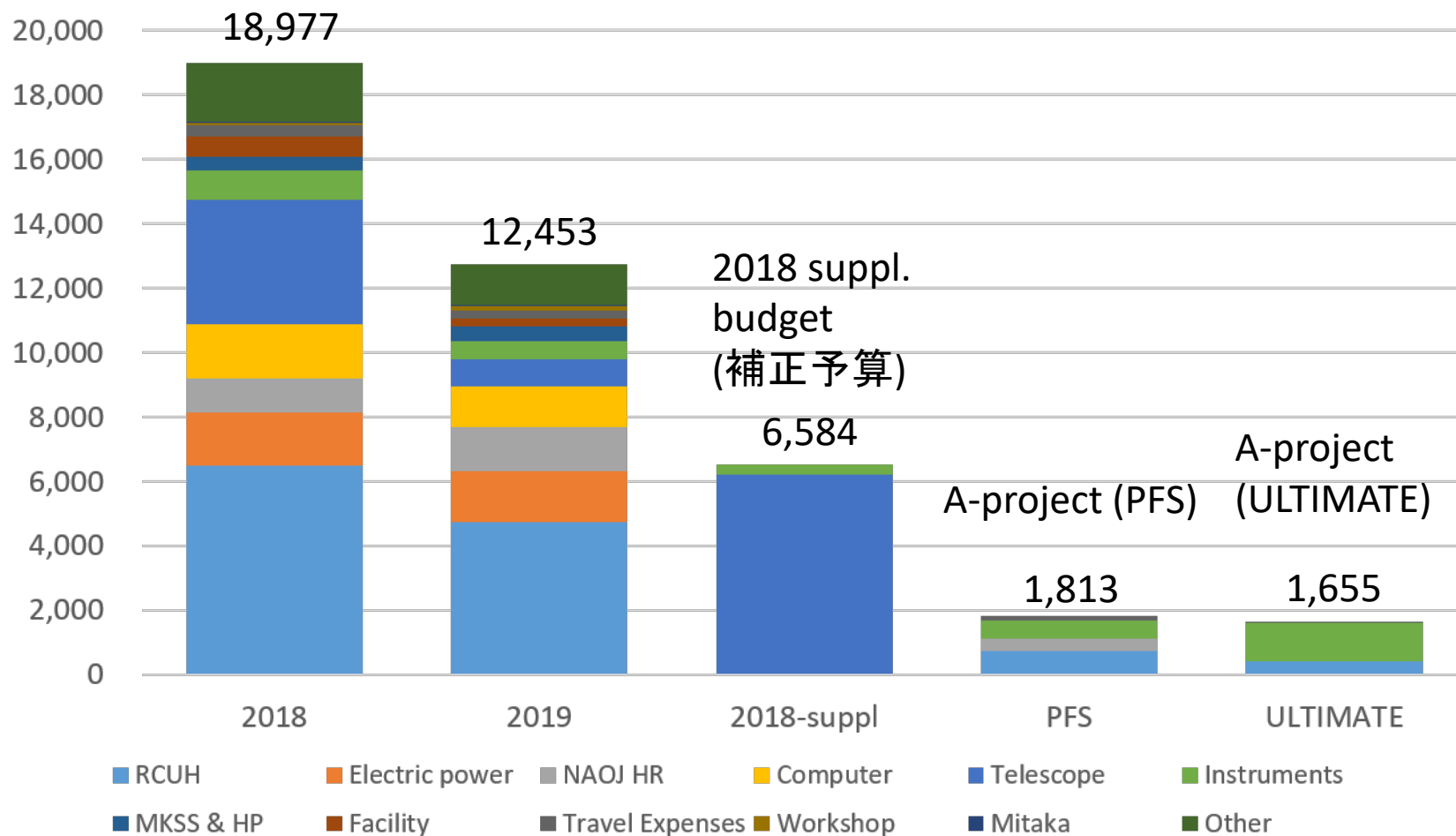



Major maintenance works

Repair of the main shutter of the Subaru dome

- ◇ From June 25 to September 8
- ◇ The work was suspended from July 16 to August 11 due to the road blockage
- ◇ The mechanical structure of the shutter slide system was replaced with new one.

IR secondary mirror recoating

- ◇ From October 23 to November 15
- ◇ The recoated surface was checked on Nov. 11 and found that it is excellent.

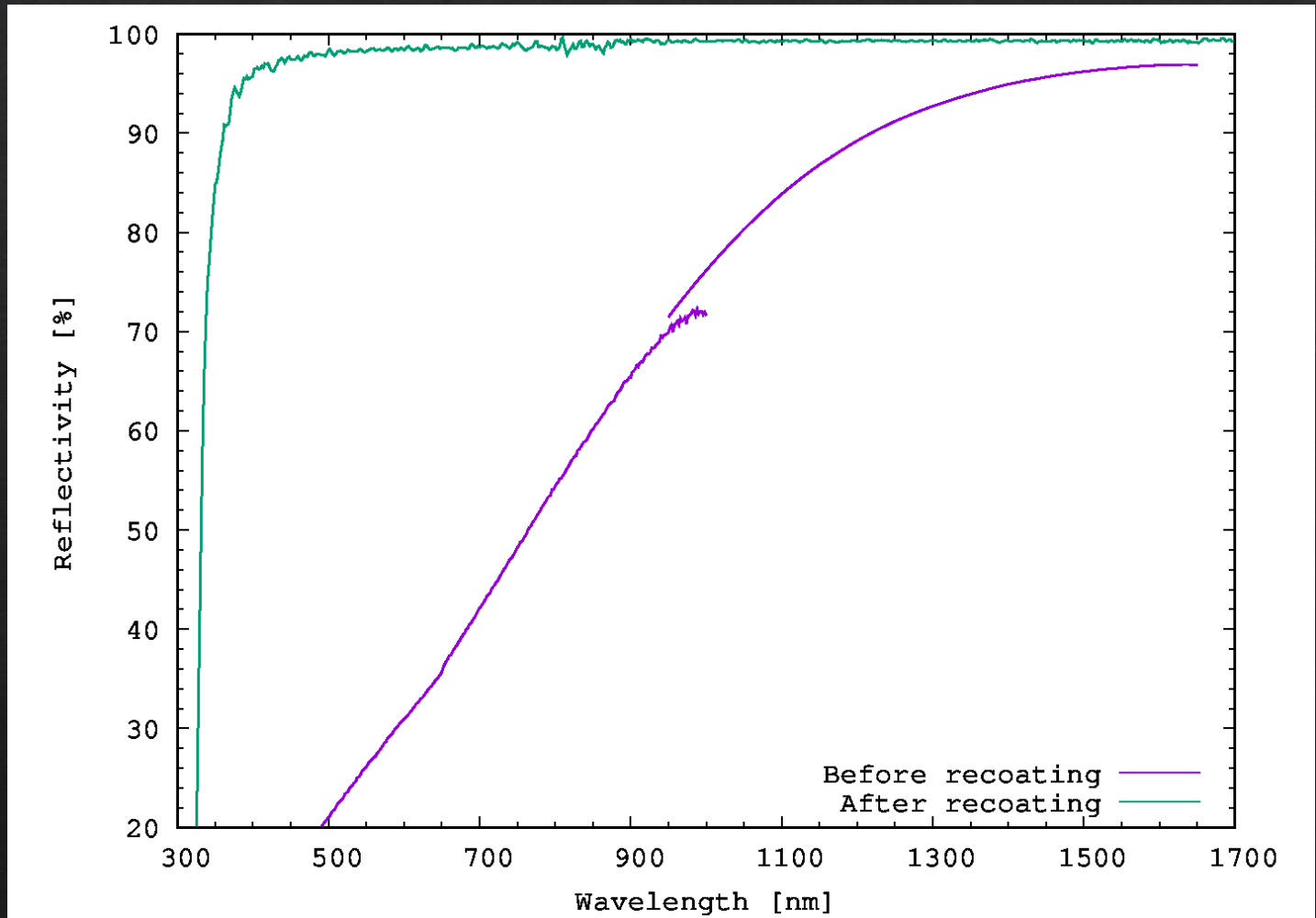

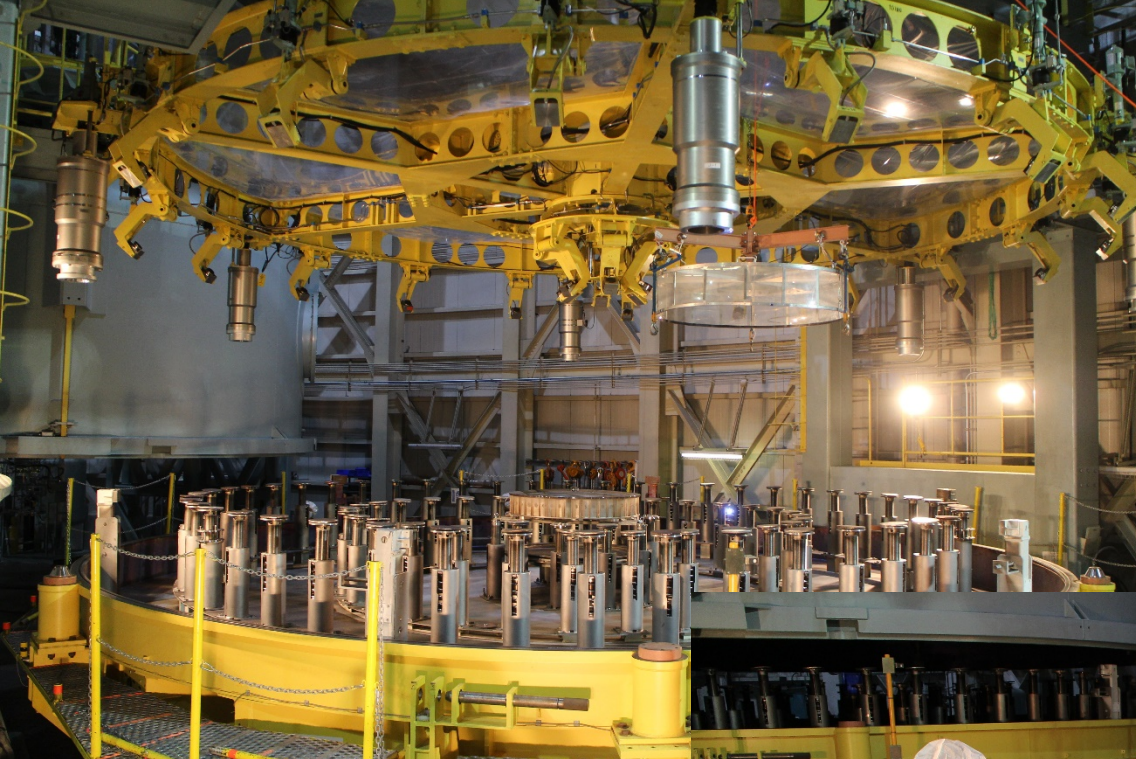

Subaru Users Meeting 2019

mid- to long-range schedule for summit work

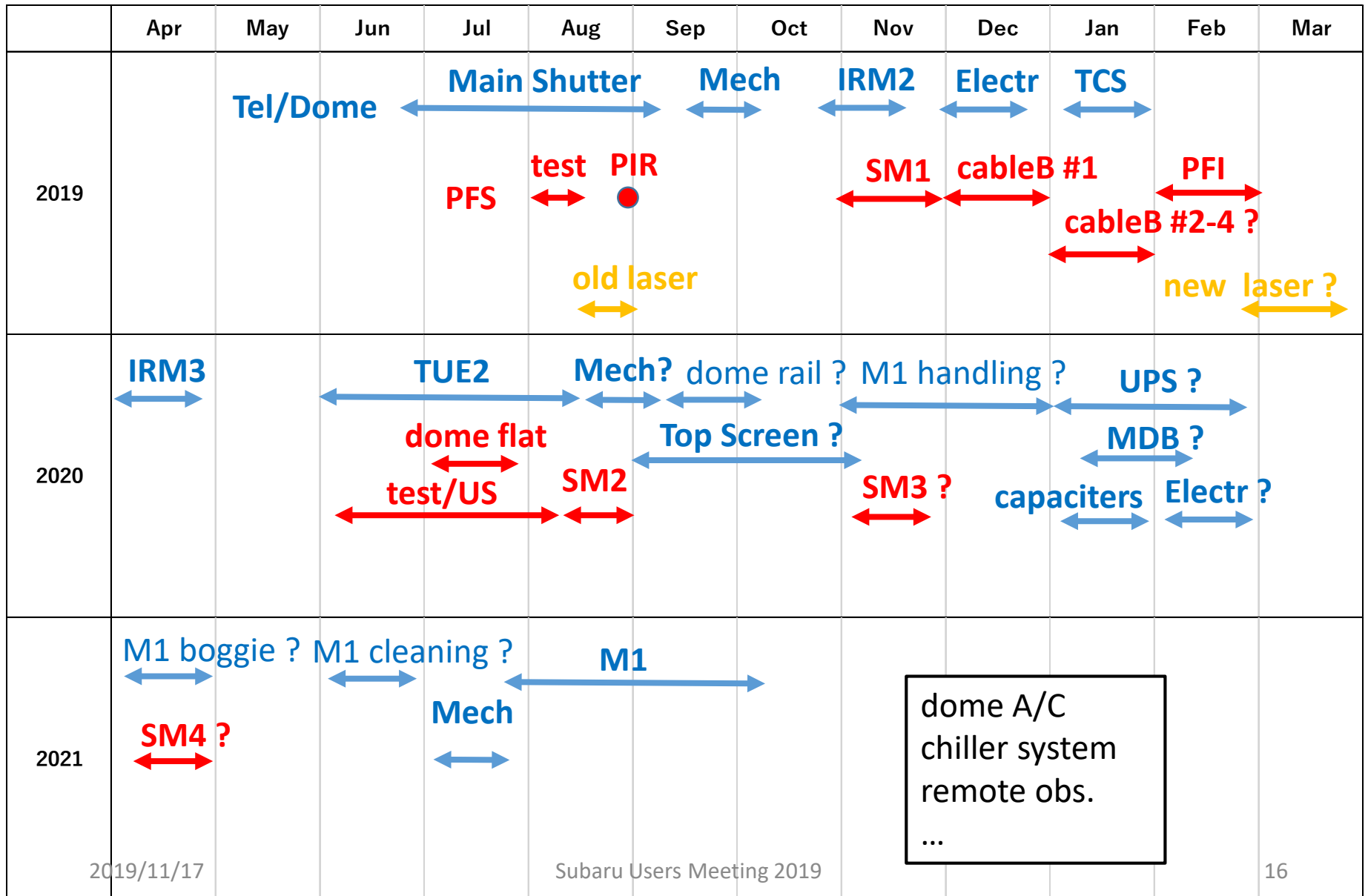



Open Use and Publications

Telescope Time Statistics

Subaru telescope time 1/25 - 11/14 2019

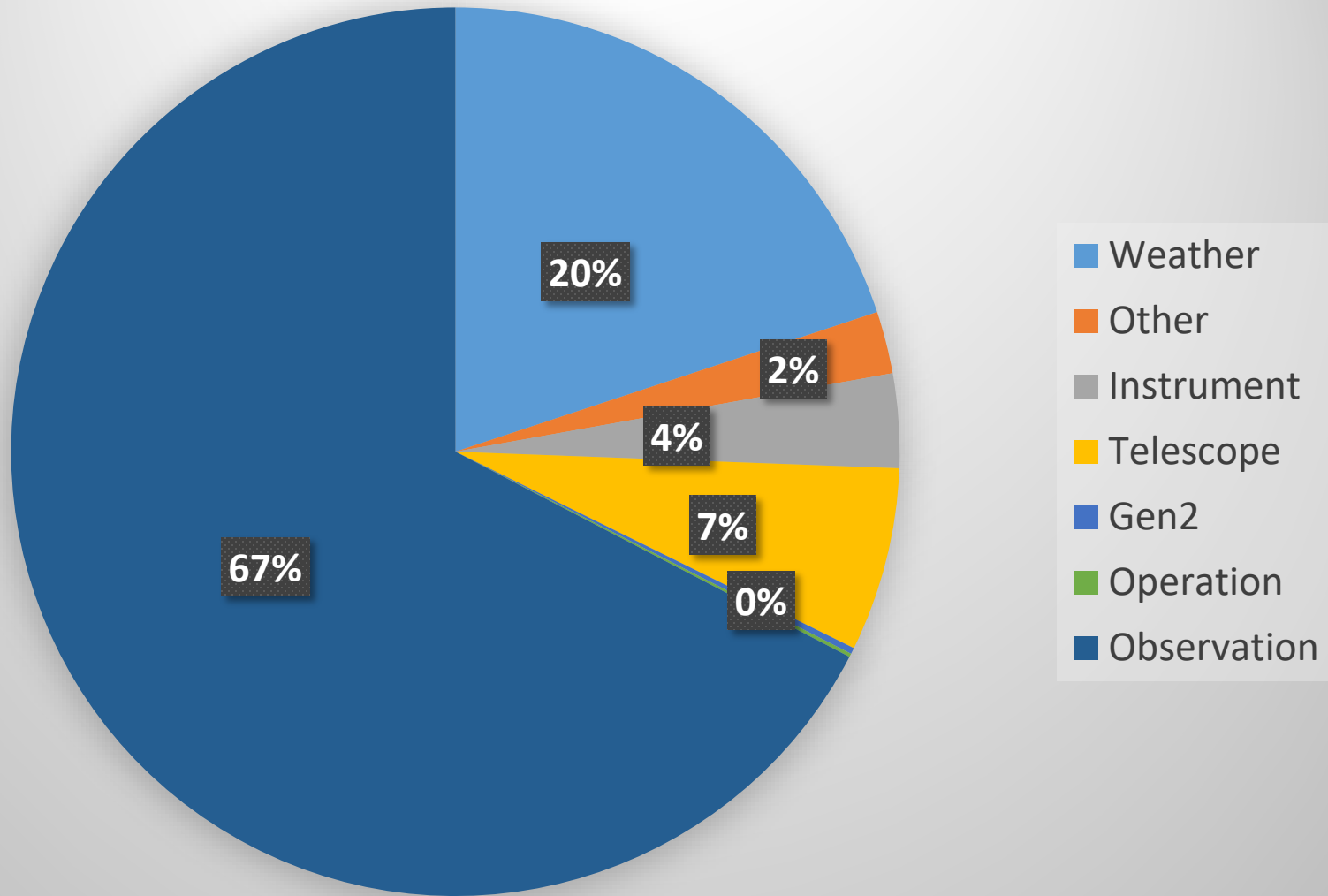



Regular Open-use night statistics

(accepted/proposed nights)

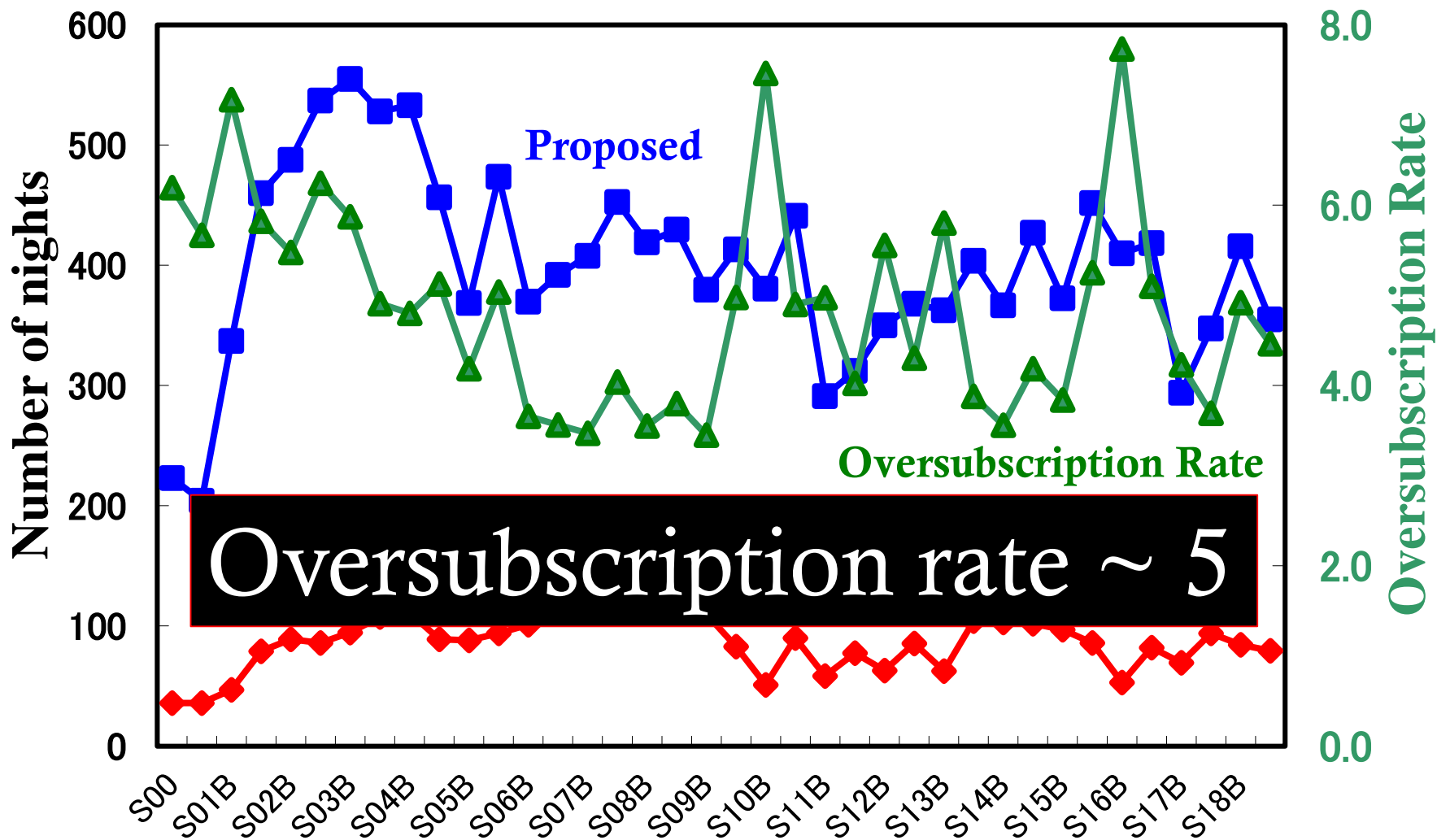

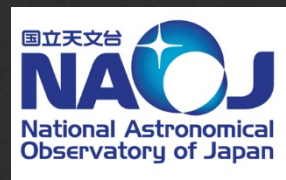

Number of publications

Number of Subaru publications

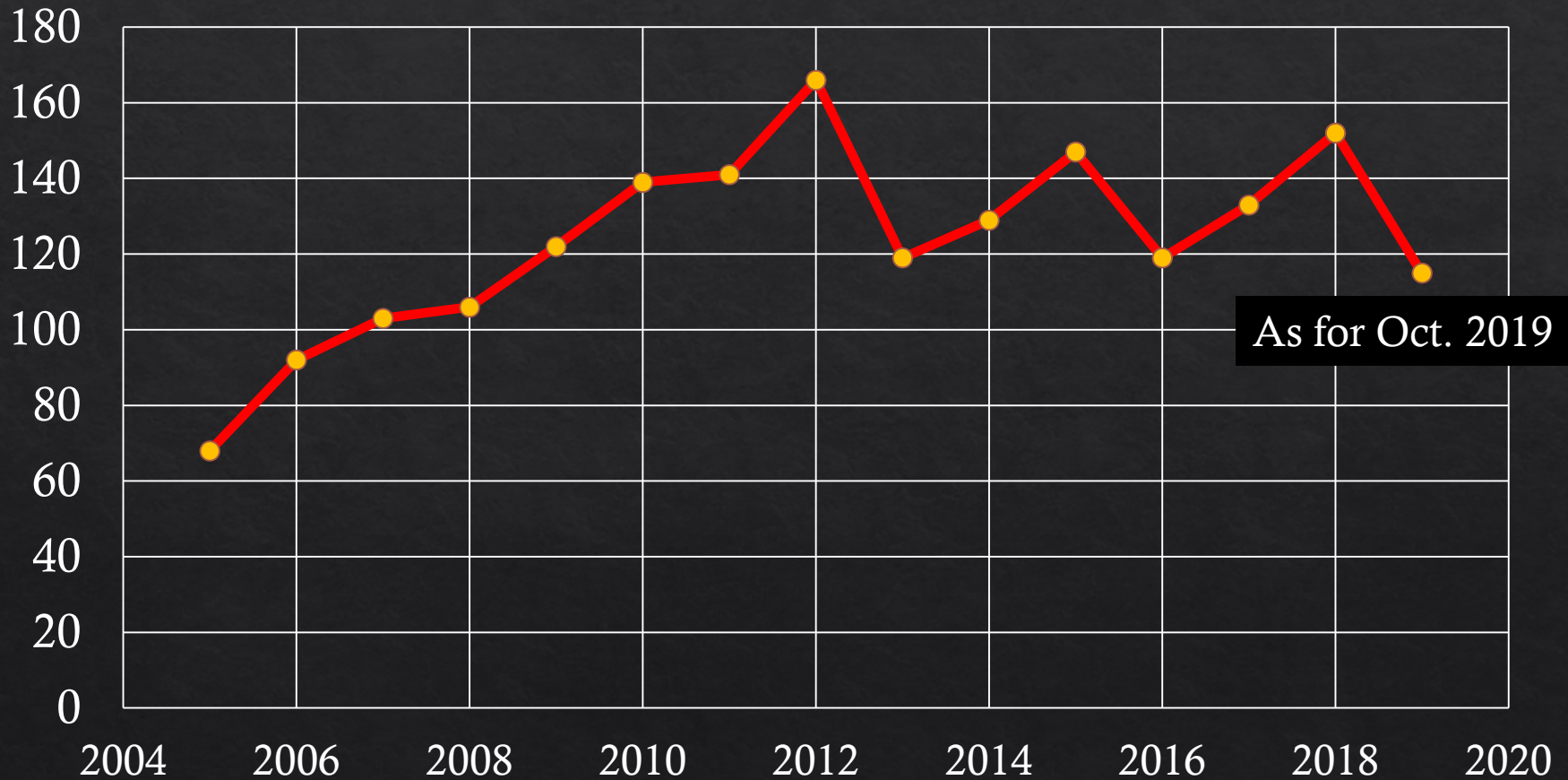

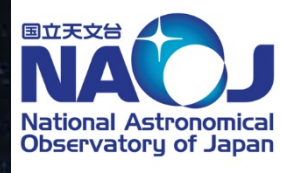

Keck/Gemini Time Exchange

Gemini-N/S

minimum 5 nights / semester

Keck-I/II

5-8 nights / semester

Astronomers set up telescope timeshare

Time swap between observatories points to closer collaboration among large telescopes.

Eric Hand

02 November 2012

Nature



Astronomers can now freely swap time on the Gemini telescopes (pictured) and Japan's Subaru telescope.

This block contains a news article snippet. It features a title, a sub-headline, the author's name, the date, and the publication name. Below the text is a photograph showing the interior of a large telescope dome, with the complex blue and white structure of the telescope's primary mirror support system visible against a sunset sky. A caption at the bottom of the image explains that astronomers can now swap time between the Gemini telescopes and the Subaru telescope.



Subaru Strategic Programs

- ◇ **HSC SSP (2014 - 2020) 300+30 nights ongoing**
 - ◇ “Wide-field imaging with **Hyper Suprime-Cam**: Cosmology and Galaxy Evolution”

2nd Public Data Release (2019 May)

<https://hsc-release.mtk.nao.ac.jp>

- ◇ **IRD SSP (2019 - 2025) 70 (+100) nights ongoing**
 - ◇ “Search for Planets like Earth around Late-M Dwarfs: Precise Radial Velocity Survey with **IRD**”
- ◇ **PFS SSP (2022 - 2027?) 300 - 360 nights in preparation**
 - ◇ Large international **PFS** collaboration



Instrumentation of Subaru



Subaru Instrumentation

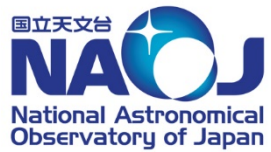

Wide field (1.5 deg) imaging

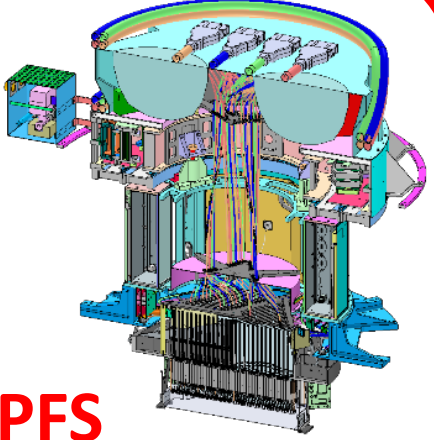

PFS
Wide field (1.3 deg)
multi object (2,400)
spectroscopy

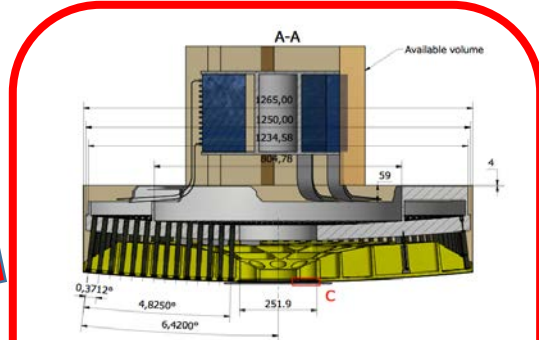
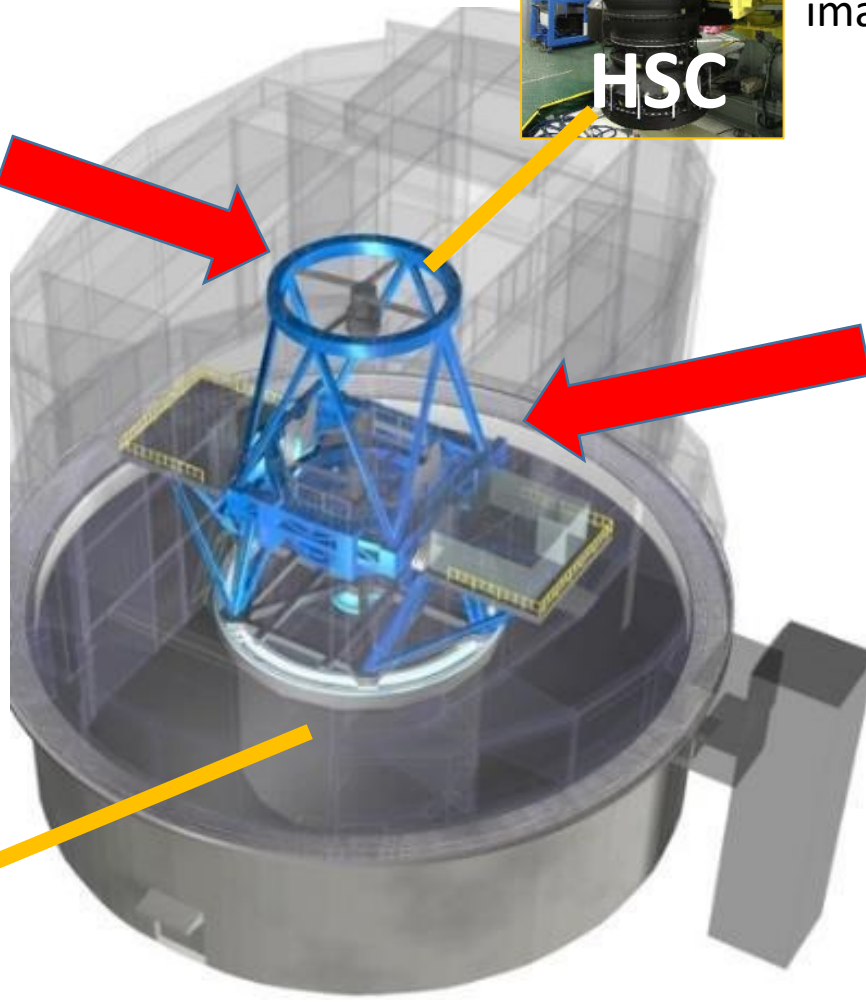

GLAO + Wide-field IR Instrument

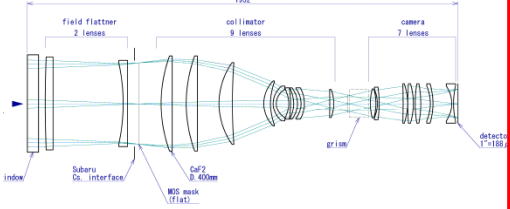

ULTIMATE-Subaru
Wide field (20 arcmin)
high spatial resolution (0.2 arcsec)
Infrared observation

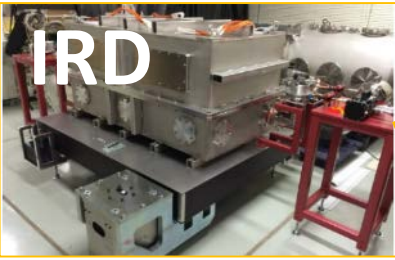

Precise radial velocity (2m/s) measurement



New Instrument

IRD (InfraRed Doppler spectrograph)

- ◇ A fiber fed **high-dispersion ($R=70,000$) NIR spectrograph** with laser frequency comb → precision of radial velocity measurement ~ 2 m/s in H-band
- ◇ Detection of earth-like mass planets around M-dwarfs
- ◇ Science operation started in S18B.
- ◇ SSP started in S19A.





PFS (Prime Focus Spectrograph)

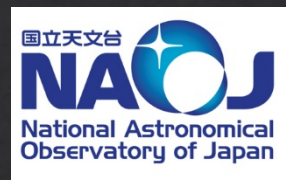

(under development; science operation from 2022)

A fiber fed **multi-object spectrograph** attached to the prime focus of Subaru

2,400 fibers FOV: 1.25 deg²

λ range: 0.38 – 1.26 μm

Spec. R: 2,300 – 5,000

Sensitivity

Band	magnitude
Blue (0.38 – 0.65 μm)	22.5
Red (0.65 – 0.97 μm)	22.4
NIR (0.97 – 1.26 μm)	21.4

S/N = 5 @ 1 hour exposure

Subaru Users Meeting 2019

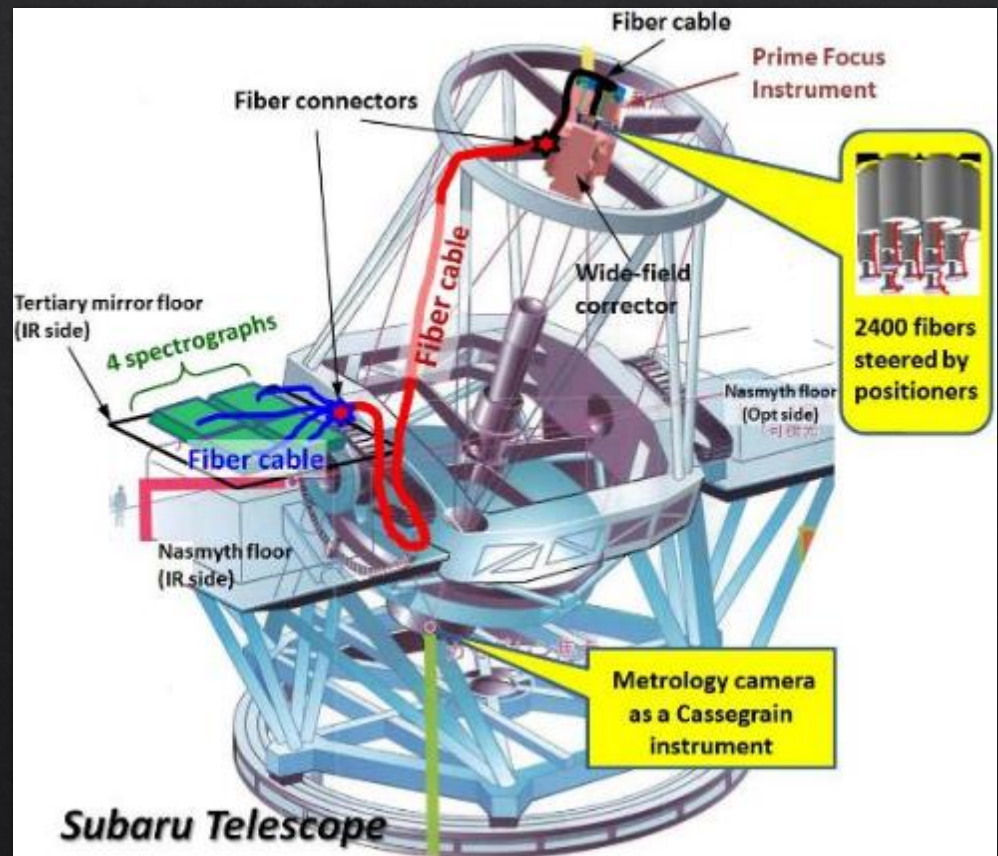

PFS Installation Timeline

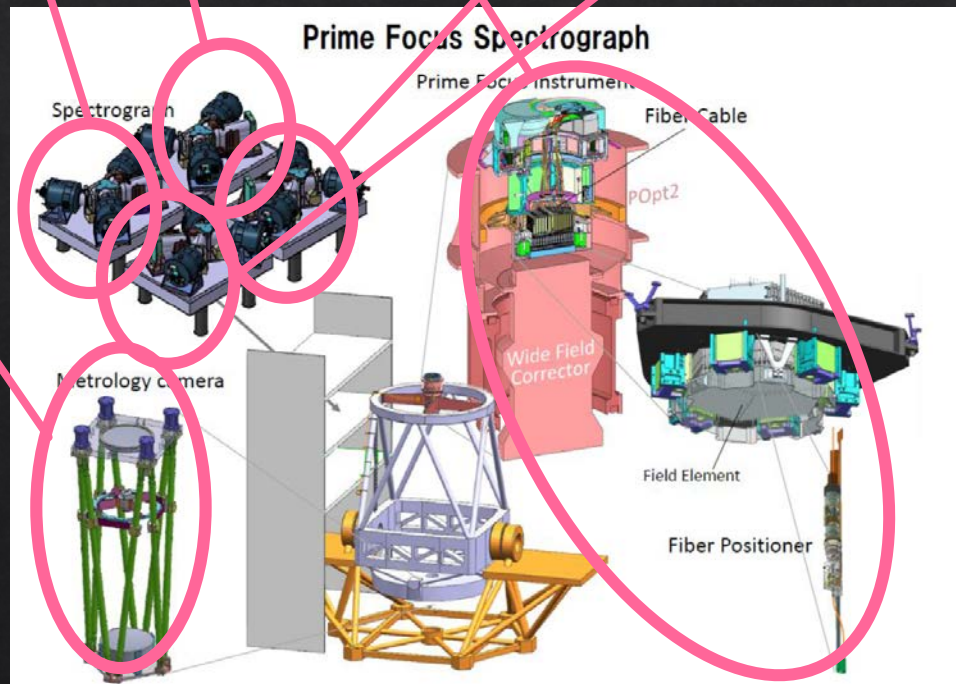
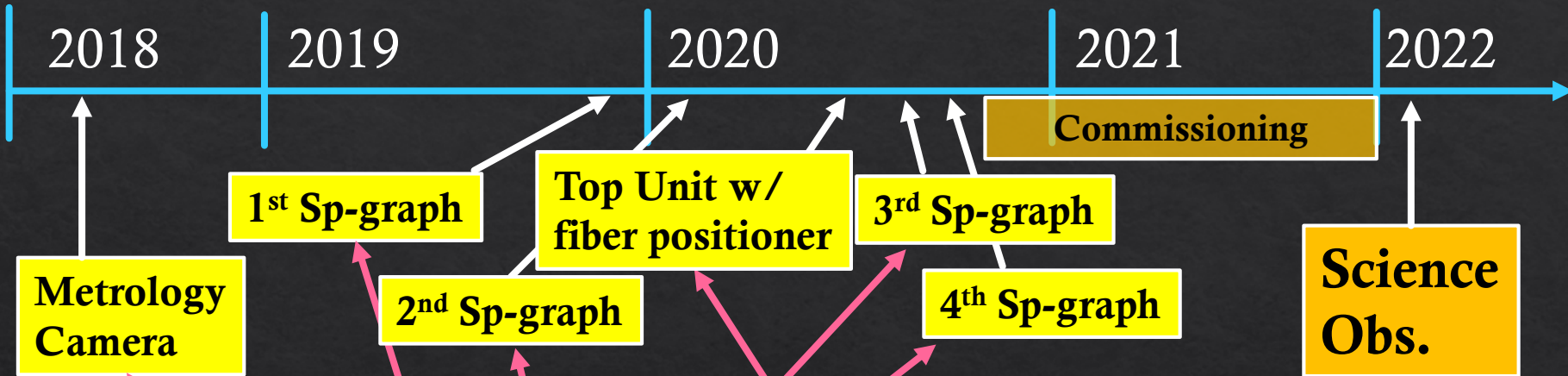

The 1st spectrograph module arrived at the Subaru Hilo base (Nov. 12)





ULTIMATE-Subaru

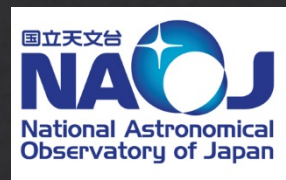

(preliminary design phase)

Wide field near-infrared observation facility using ground layer adaptive optics (GLAO) system

Conceptual Design Review was done in Oct. 2018 !!

Science Operation: 2026

4 Laser Guide Star System

Deformable Secondary Mirror

Wavefront Sensors

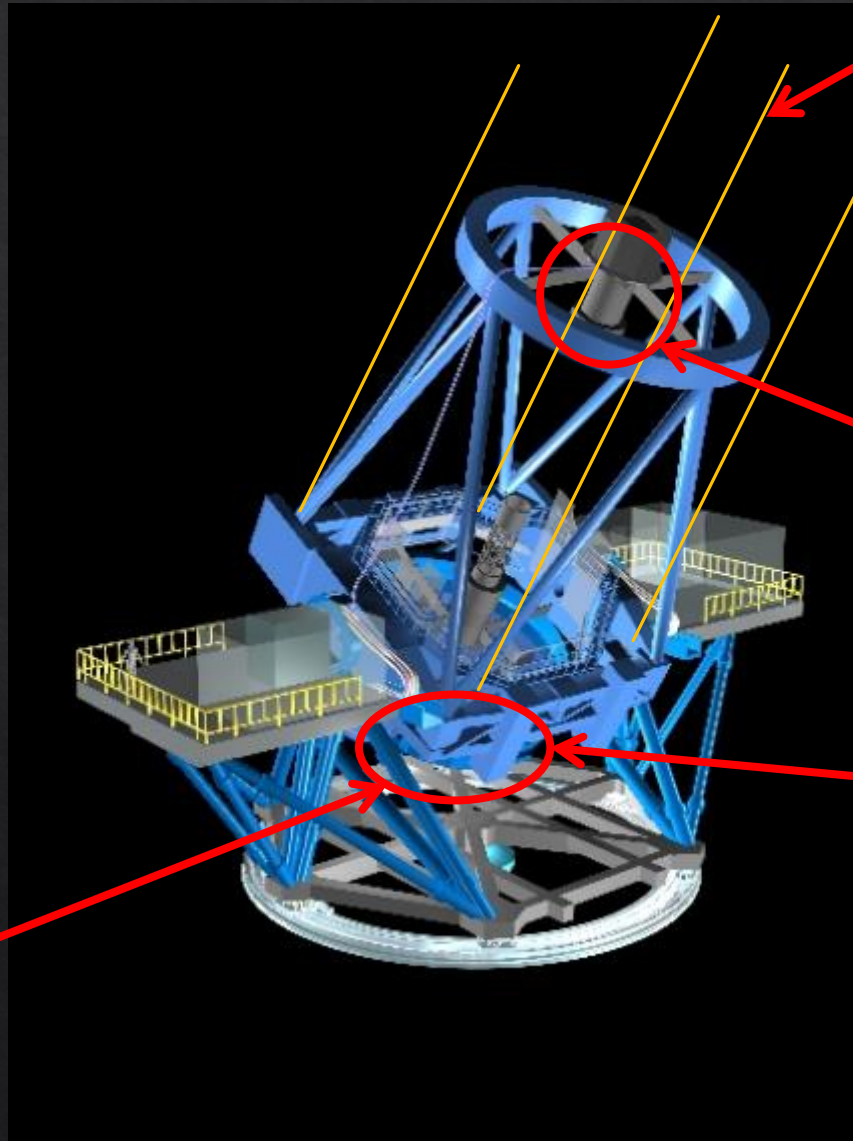

Wide Field Near-infrared Instruments

Subaru wide-field capabilities in 2020s

HSC (operational)



Optical
(0.38 – 1.1 μm)

FoV
1.7 deg²

Seeing limited
($> 0.4''$)
Imager

Limiting mag.
with 1h exp.

Band	mag
g	27.8
r	27.2
i	26.5
z	25.9

PFS (2022 -)

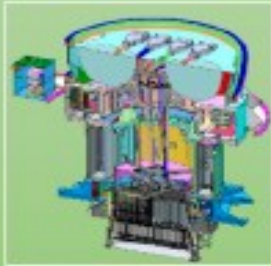

Optical – J-band
(0.38 – 1.26 μm)

FoV
1.3 deg²

2,400 fibers
1.05" ϕ
Multi-object sp.
0.38 – 1.26 μm

Limiting mag. with 1h exp.

Band	mag
Blue (0.38 – 0.65 μm)	22.5
Red (0.65 – 0.97 μm)	22.4
NIR (0.97 – 1.26 μm)	21.4

ULTIMATE (2026 -)



Near-Infrared
(0.9 – 2.5 μm)

FoV
20' ϕ

GLAO supported
0.2" resolution
(in K-band)

Imager (14'x14')
Multi-object sp.
(w/ MOIRCS)
IFU sp.

Limiting mag.
using GLAO
with 4h exp.

Band	mag
J	26.3
H	25.5
Ks	26.4
NB1340	26.1



Subaru Instrumentation Plan

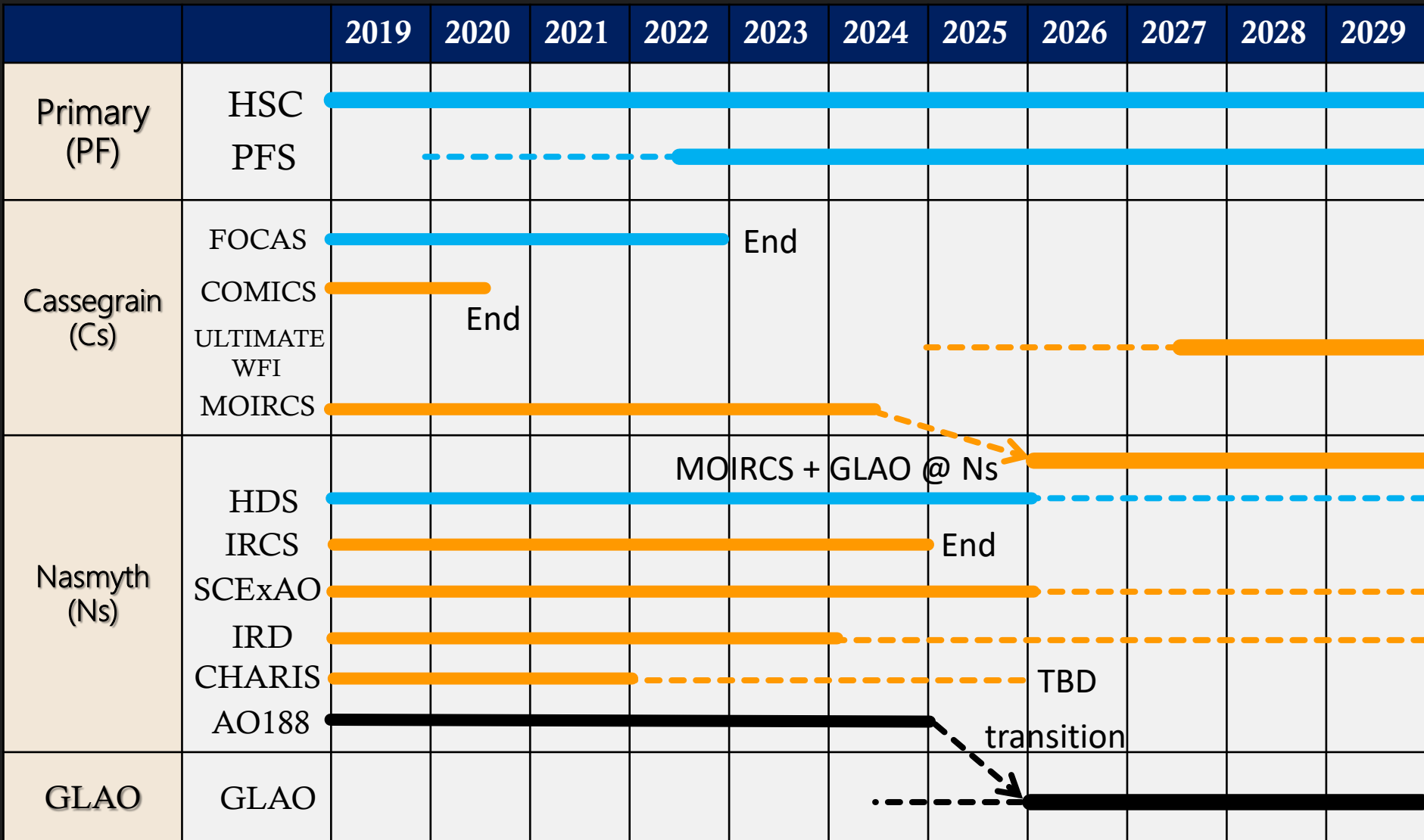
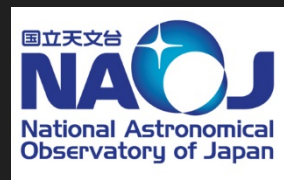



International Partnership

- ◇ Subaru is seeking for international partners who can operate the telescope together.
- ◇ Discussions on international partnership with partner candidate countries are under way.
- ◇ Partner candidates:
 - ◇ India
 - ◇ Canada
 - ◇ East Asian Observatory



International Partnership with India

- ◇ Discussion on India participation in Subaru operation started December 2018.
- ◇ Subaru – India meeting on international partnership was held in Bengaluru on September 9 – 10, 2019.
- ◇ Subaru – India science collaboration meeting will be held in Mumbai on December 19 – 21, 2019.





Summary

- ◆ Subaru is one of the highest competitive telescopes in the world. The oversubscription rate of the proposals is about 5.
- ◆ Number of annual science publications is $\sim 120 - 150$ (152 in 2018).
- ◆ Two large programs (Subaru Strategic Programs) are running using HSC and IRD. HSC-SSP is allocated 300 nights from 2014 to 2020 and 70% of the project has been done. IRD SSP started from S19A and 70 nights are initially allocated to this project (finally, 170 nights may be allocated).
- ◆ Development of Prime Focus Spectrograph (PFS) is going well. Science observation of PFS will start in 2022.
- ◆ Conceptual design of the Wide field infrared observation facility, ULTIMATE, has been done successfully. The ULTIMATE project proceeds to preliminary design phase.
- ◆ Subaru is exploring international partners for sustainable operation of the telescope.



Thank you